

Catalogue	MITO 2013-2018	
Category	20.8 BODYSHELL PANELS (REAR PART)	
Var.	01	
Rev.	00	

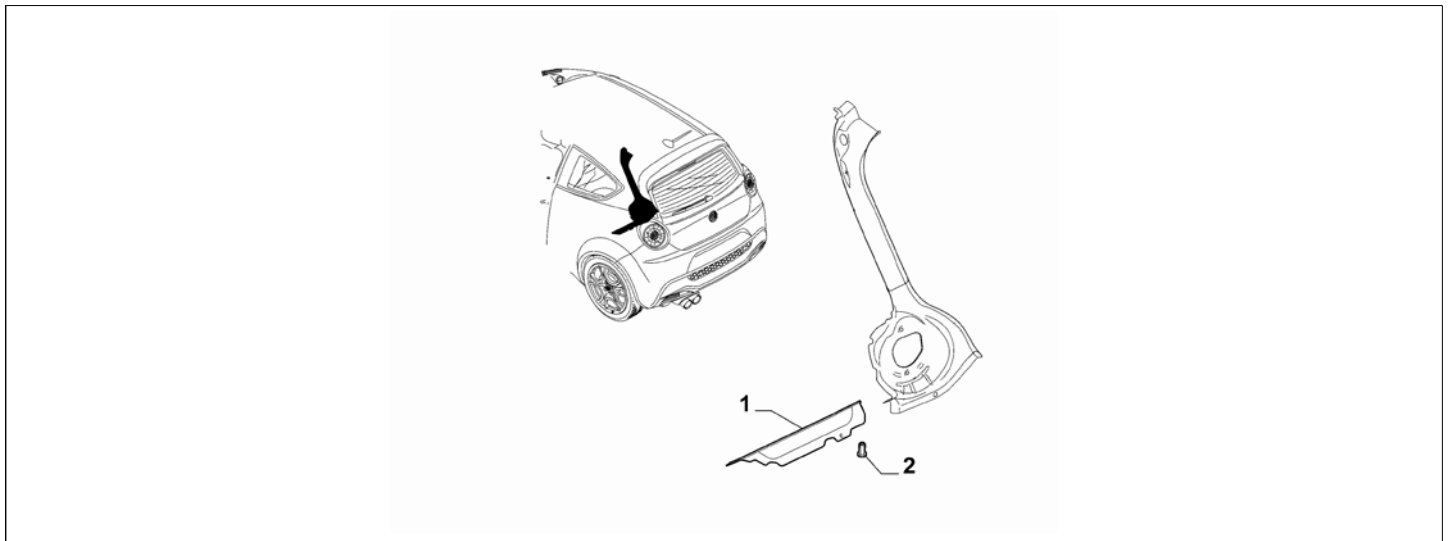

Part Num.	Description	Compatibility	Modif.	Qty	Notes	Col.	Reman.
1	50509070 REINFORCEMENT, RIGHT			1			
1	50509071 REINFORCEMENT, LEFT			1			
2	7765139 RIVET			2			

Catalogue	MITO 2013-2018	
Category	20.8 BODYSHELL PANELS (REAR PART)	
Var.	01	
Rev.	00	

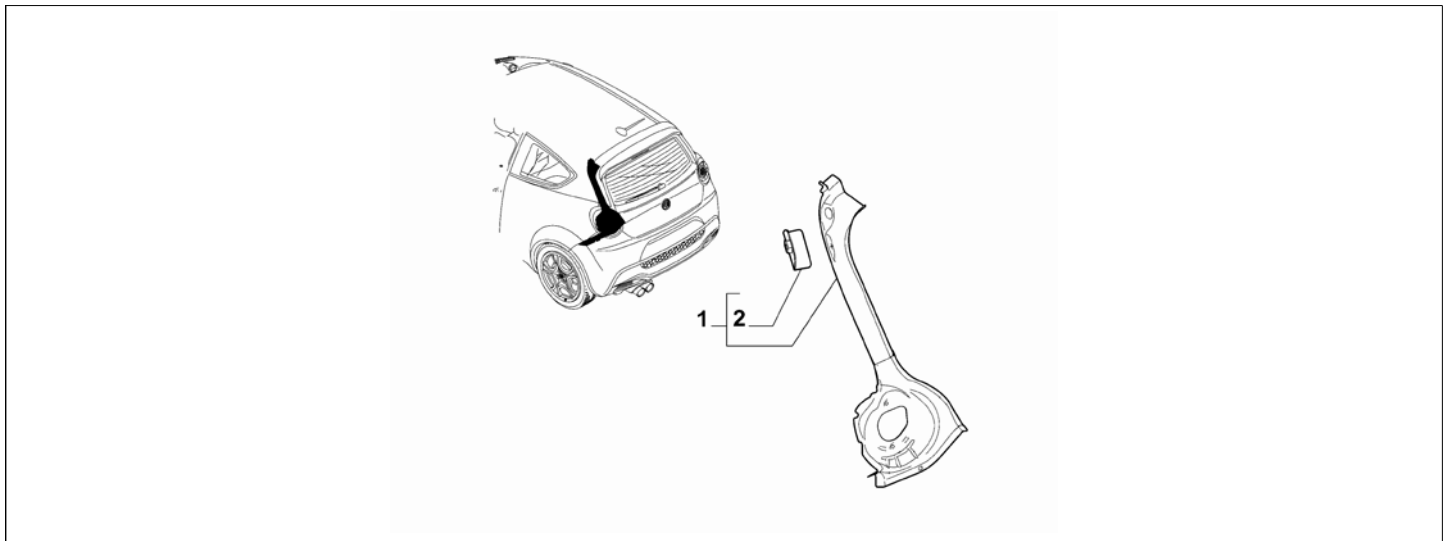

Part Num.	Description	Compatibility	Modif.	Qty	Notes	Col.	Reman.
1	50508714 END PLATE, RIGHT			1			
1	50508721 END PLATE, LEFT			1			
2	50508718 BRACKET, RIGHT			1			
2	50508725 BRACKET, LEFT			1			