

Catalogue	MITO 2013-2018	
Category	20.7 BODYSHELL PANELS (CENTRAL PART)	
Var.	01	
Rev.	00	

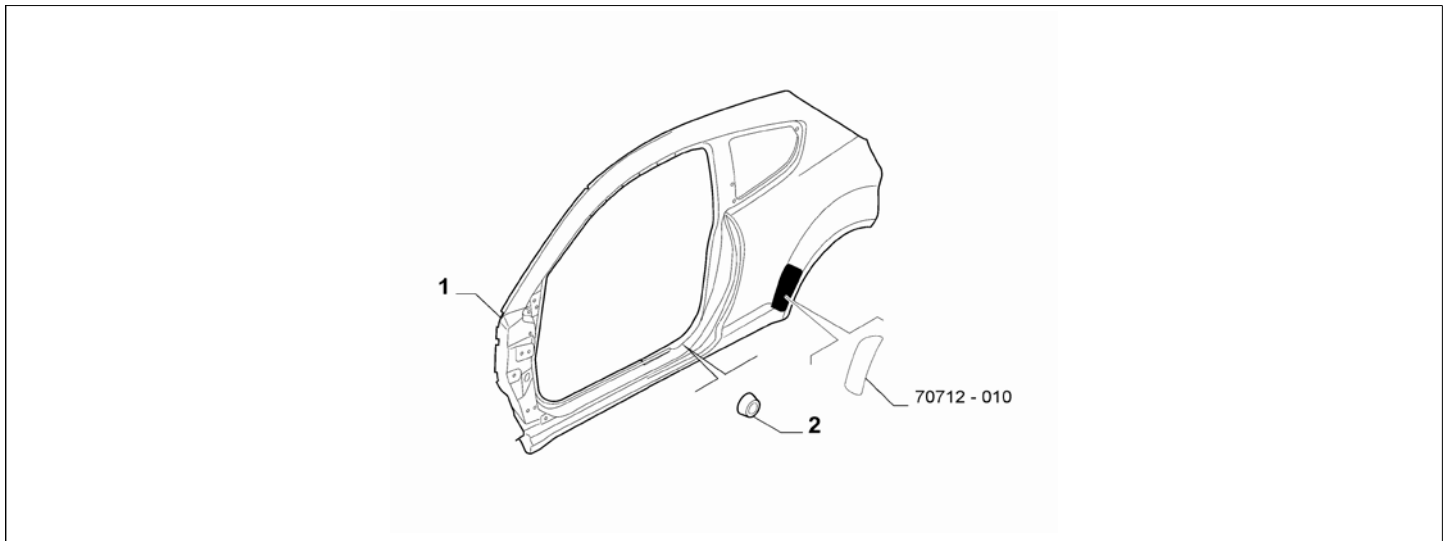

Part Num.	Description	Compatibility	Modif.	Qty	Notes	Col.	Reman.
1	50516423 SIDE PANEL, RIGHT			1			
1	50516424 SIDE PANEL, LEFT			1			
2	46516811 WICK			2			

Catalogue	MITO 2013-2018	
Category	20.7 BODYSHELL PANELS (CENTRAL PART)	
Var.	01	
Rev.	00	

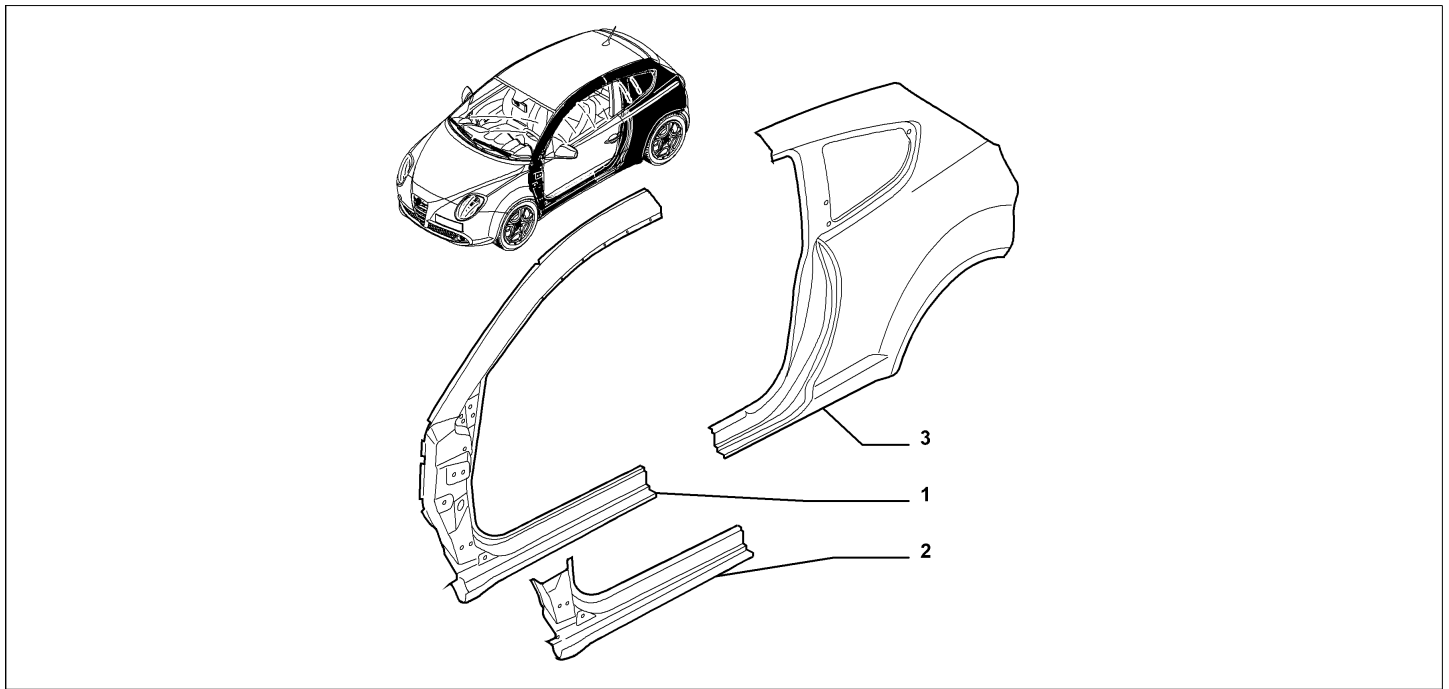

Part Num.	Description	Compatibility	Modif.	Qty	Notes	Col.	Reman.
1	71753246 METAL LINING, RIGHT			1			
1	71753247 METAL LINING, LEFT			1			
2	71753248 METAL LINING, RIGHT			1			
2	71753249 METAL LINING, LEFT			1			
3	71753250 REAR FENDER, RIGHT			1			
3	71753251 REAR FENDER, LEFT			1			

Catalogue	MITO 2013-2018	
Category	20.7 BODYSHELL PANELS (CENTRAL PART)	
Var.	01	
Rev.	00	

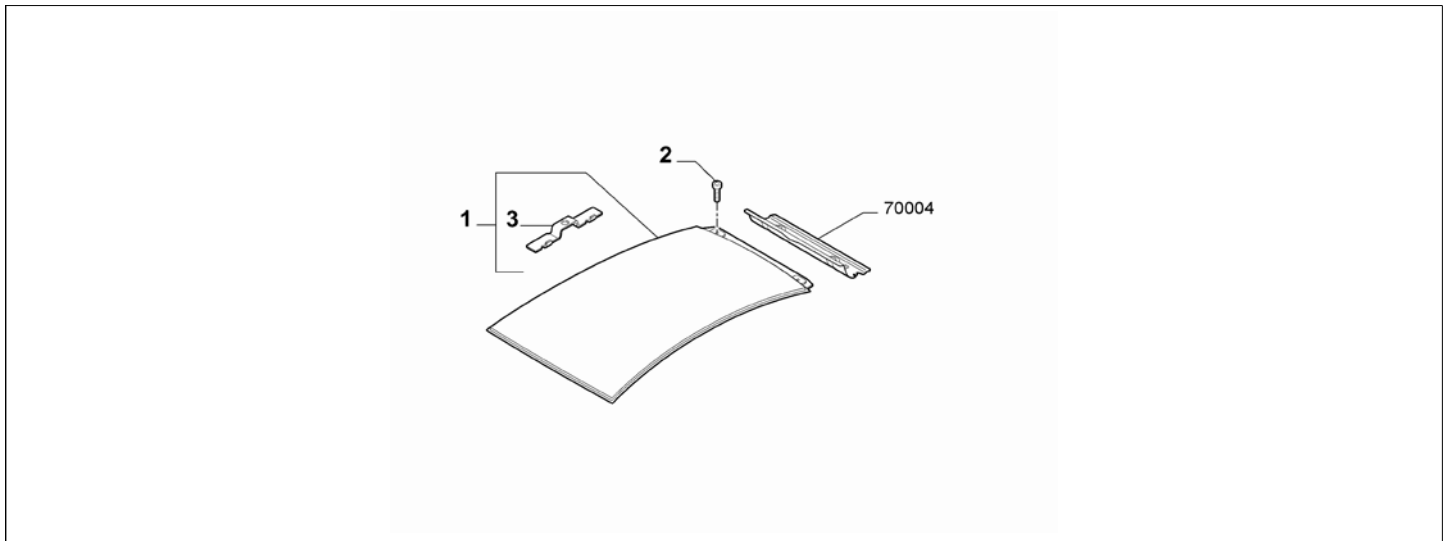

Part Num.	Description	Compatibility	Modif.	Qty	Notes	Col.	Reman.
1	50518335 ROOF PANEL	1400		1			
1	50518336 ROOF PANEL	400		1			
2	18750121 SCREW, M6X14	400		6			
3	50518333 REINFORCEMENT			4			

Legend	
400	LONG OPENABLE ELECTRIC SUNROOF