

Catalogue	MITO 2013-2018	
Category	20.6 BODY SHELL PANELS (FRONT PART)	
Var.	02	
Rev.	00	

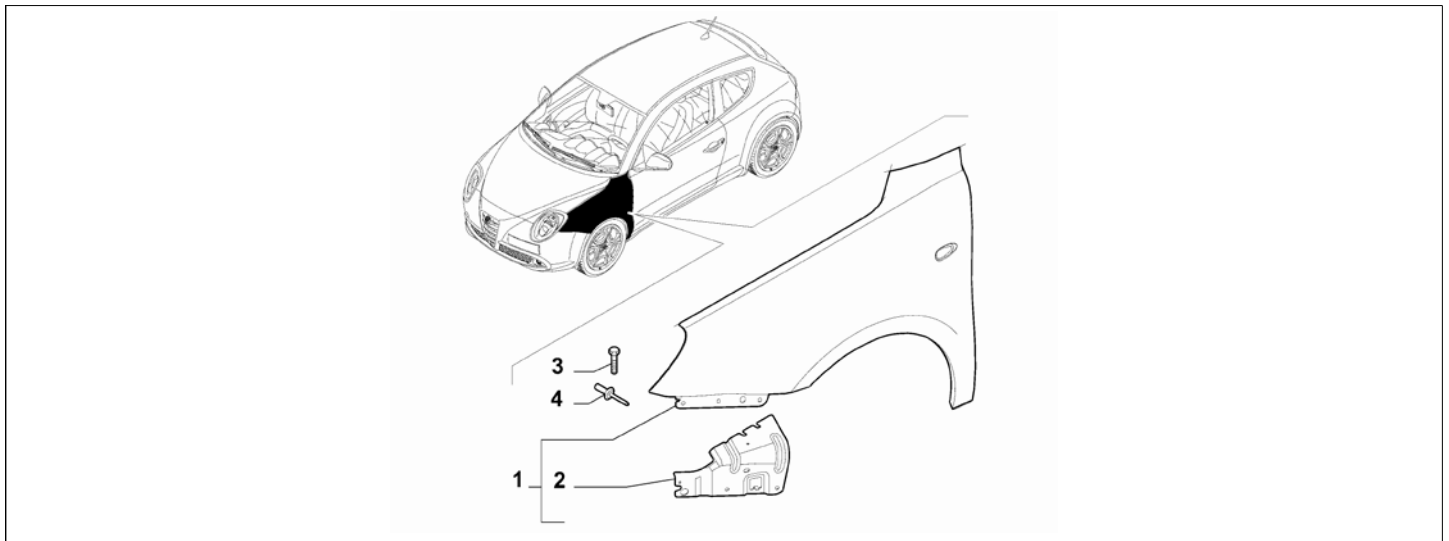

Part Num.	Description	Compatibility	Modif.	Qty	Notes	Col.	Reman.
1	50509311 FRONT FENDER, RIGHT			1			
1	50509337 FRONT FENDER, LEFT			1			
2	50509198 BRACKET, RIGHT			1			
2	50517700 BRACKET, LEFT			1			
3	46808452 SCREW AND WASHER ASSY, M6X20			4			
3	10707024 SCREW, M6X18			14			
4	51765588 CLIP			2			