

Catalogue	MITO 2011-2013	
Category	20.1 WORKED BODY	
Var.	01	
Rev.	00	

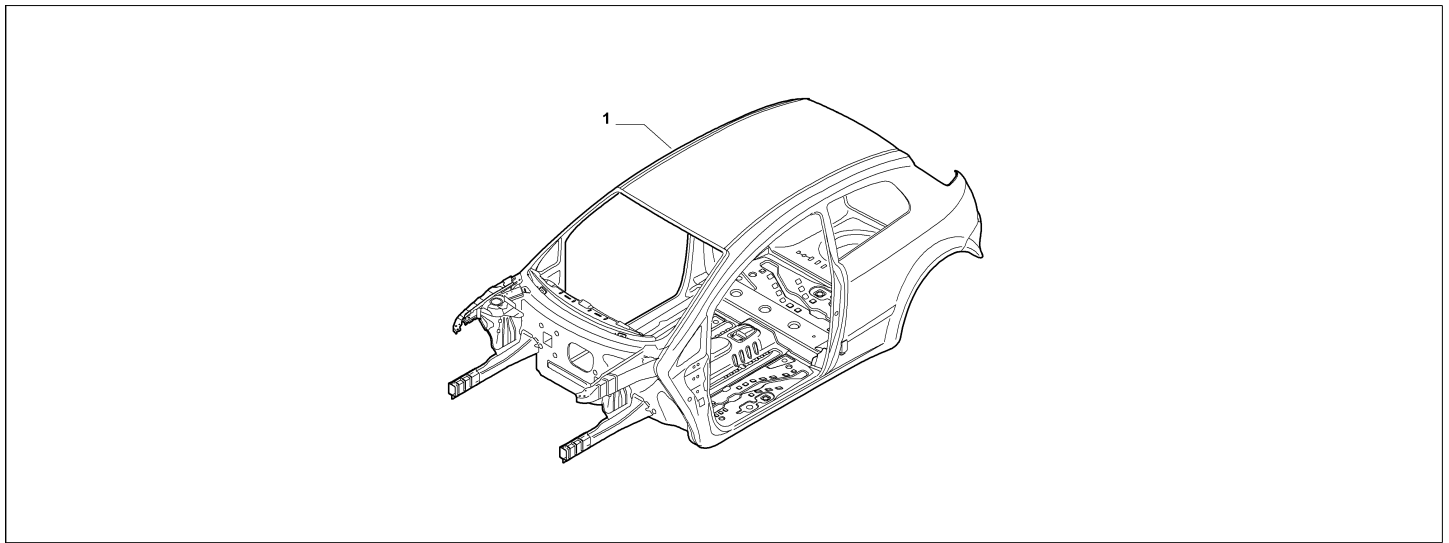

Part Num.	Description	Compatibility	Modif.	Qty	Notes	Col.	Reman.
1	50516188	BODY SHELL	LHD+!(400, 926)		01	SUPPLIED DURING THE PRODUCTION	
1	50516189	BODY SHELL	LHD+400+1926		01	SUPPLIED DURING THE PRODUCTION	
1	50516190	BODY SHELL	RHD+!(400, 926)		01	SUPPLIED DURING THE PRODUCTION	
1	50516191	BODY SHELL	RHD+400+1926		01	SUPPLIED DURING THE PRODUCTION	

Legend	
400	LONG OPENABLE ELECTRIC SUNROOF
926	SIDE SKIRTS
RHD	STEERING:RIGHT
LHD	STEERING:LEFT